

AUTOMOTIVE SOLUTIONS

CATALOGUE



VEHICLE TESTING SOLUTIONS, CUSTOMIZED SOFTWARE AND OUTSOURCING

LEANE Automotive Division

Since 1978 we put our commitment in satisfying our customers' needs. Starting from sensors, we increased our expertise, extended our team, improved our skills and developed more competences in order to deliver the best possible solutions.

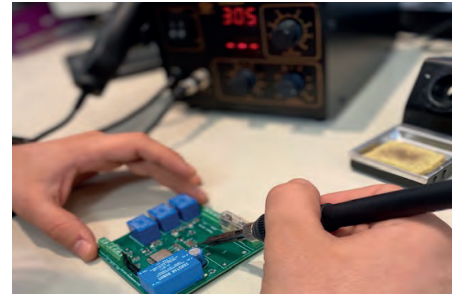

WE ARE

With over forty years of experience and highly specialized engineering expertise, we are able to provide our customers with the best solutions from the choice of the right sensor to the final report.

OUR OFFERS

From the single sensor to a complete turnkey measurement system, from road testing to driving simulator, we have a wide offer of stand-alone devices as well as the ability to build complete solution tailored on your application.

OUR STRENGTHS

We are a small and dynamic company made of people with proven expertise, animated by passion and focused on the need of the customer. We target a high quality standard, and our commitment was proven by the CRIBIS certification.



Our Added Value



CONSULTING



CUSTOM
SOLUTIONS
DEVELOPMENT



ASSISTANCE



CONTRACTS
MAINTENANCE
OUTSOURCING

Our offer starts with the commitment to understand your needs and ends up with on site technical support, maintenance and outsourcing services. We support you in choosing of the right devices and integrate them all in a turnkey solution for your application.



HW & SW that make a difference

Engineering and system integration

LEANE Outsourcing services

Our team:

- Sw engineer
- Test engineer
- Data analyst
- Team Consulting

Our competence:

- Vehicle dynamics
- Braking, ADAS, Performance
- EV, HEV
- Physical and Virtual testing

Our equipments:

- Sensors and DAQ systems
- Driving robots
- VRU carriers
- Soft targets
- Complete Solutions for ADAS Test

Alone you go faster but together we go further!



A solution for every application

Overview	Vehicle Dynamics	Braking	Performance	Consumption	Power Train	E.V.	ADAS	Durability	Monitoring
	ABDynamics	■	■					■	■
Dewesoft	■	■	■	■	■	■	■	■	■
dQdt				■	■				
GeneSys	■	■	■				■	■	
Moshon Data							■		
Rototest					■	■			
Suchy Data Systems		■	■	■				■	■
Optimeas									■



Thanks to a strong network of partners able to provide state of the art testing equipment we can satisfy the most demanding requirements for many applications.

Your **“One-Stop Shop”**
for vehicle testing!

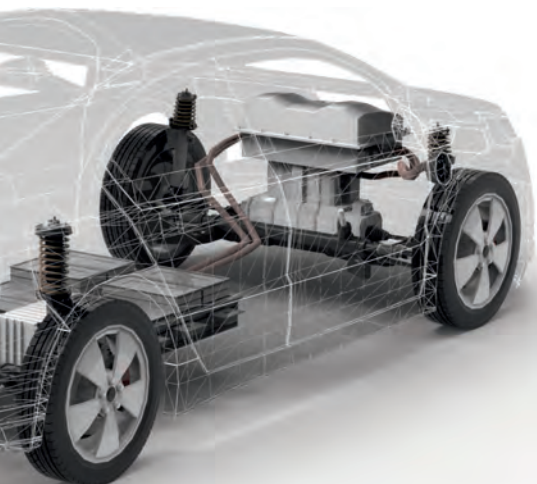

VEHICLE DYNAMICS BRAKING PERFORMANCE CONSUMPTION



OBJECTIVE HANDLING ANALYSIS



OBJECTIVE BRAKING ANALYSIS



PERFORMANCE & FUEL CONSUMPTION



MOTORCYCLE BRAKING & PERFORMANCE



Fields of application

Simultaneous data acquisition from whatever data source. All-in-one or distributed system. Overall vehicle behavior and in depth subsystems analysis. Compact and cost effective solutions for simple performance tests.

YOUR SOLUTION	Vehicle Dynamics	Braking	Performance	Consumption
ABDynamics	■	■		
Dewesoft	■	■	■	■
dQdt				■
GeneSys	■	■	■	
Suchy Data Systems		■	■	■



HARDWARE

DEWESOFT SIRIUS LINE

All-in-one solution based on R2DB/R1DB or a modular solution based on rugged SBox PC and daisy-chained Sirius slices to acquire perfectly synchronized data from any type of sensors and bus interface.



ABDynamics STEERING ROBOT

Precise and reproducible steering input in a wide range of steering amplitude and velocity. Ideal for the highest dynamic handling maneuvers as well as for the on-center objective evaluation. Application software Path Following for centimeter-level position accuracy. Data output via CAN.

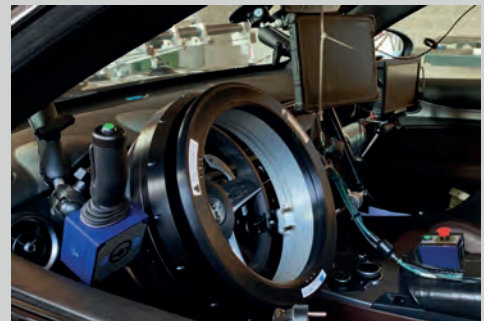

GeneSys ADMA INS-GNSS

An ADMA G-series IMU, featuring top quality accelerometers, optical gyros and GPS RTK2, is recommended for accurate measurement of the vehicle motion variables. All ADMA's have a state of the art Kalman filter that guarantees further improved stability and minimal drift. Data output via CAN and Ethernet.



SOFTWARE

DEWESOFT X and Vehicle Testing Suite (VTS)

Award-winning data acquisition software. Experience data recording, signal processing and data visualization like never before. Our VTS user interface is designed for easy and safe operation on the track. State of the art signal processing, calculation of objective metrics according to ISO standards, automatic and quick validation check at the end of each test run are the key features that increase the driver's productivity on the track.





OBJECTIVE BRAKING ANALYSIS

HARDWARE

DEWESOFT SIRIUS LINE DEWESoft[®] measurement innovation

All-in-one solution based on R2DB/R1DB or modular solution based on sBox rugged PC and Sirius slices. Additional Krypton TH Ethercat modules distributed around the vehicle allow to manage a number of thermocouples by connecting just one cable to the data logger.



- High-end Signal Conditioning
- All-in-one Instrument
- Compact, mobile and portable

ABDynamics BRAKING ROBOT

Precise and reproducible brake pedal actuation in force, displacement or deceleration. Ideal for objective evaluation of the pedal feel, assessment of emergency brake assist functions (AEB), repeatable NVH and fade test protocols.



- Max brake force 750N or 1500N
- Upgradeable for driverless testing
- Versatile robot for brake tests and speed control



GeneSys ADMA INS-GNSS

ADMA Speed is a cost efficient solution ideal for brake testing. Quick and easy to install, it features high quality MEMS sensors and GPS with RTK option. The GeneSys Kalman filter performs the same data fusion algorithm as the other ADMAs, delivering reliable measurement of the vehicle motion variables.



- Pitch compensation during braking
- Speed and signal-triggered braking distance
- Precise speed measurement

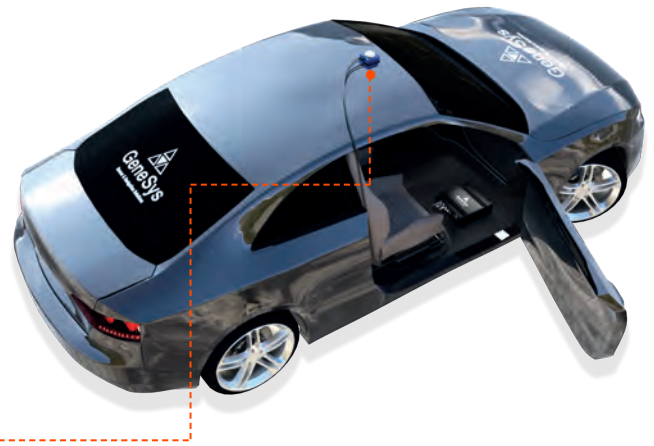

- Data processing unit
- Compensation of GNSS data latency
- Quick and easy installation

SOFTWARE

DEWESOFT X and Vehicle Testing Suite

Our VTS user interface is designed for easy and safe operation on the track. Leane developed dedicated VTS plugins for braking and tyre testing, based on customer's test protocols for complete performance evaluation and characterization of the braking system.

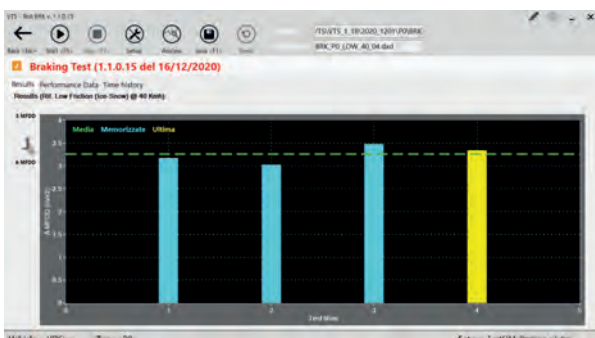

- Stopping distance
- Pedal feel
- Fade
- Cooling
- Brake Assist (ECE 13H)
- and more...





PERFORMANCE & FUEL CONSUMPTION



HARDWARE

DEWESOFT SIRIUS LINE

All-in-one solution based on R2DB/R1DB or a modular solution based on rugged SBox PC and daisy-chained Sirius slices to acquire perfectly synchronized data from any type of sensors and bus interface.



dQdt FUEL METER

Designed in order to fit any fuel system configuration (with/without return to tank), any fuel, with temperature compensation and dynamic compensation of the pressure drop through the sensor.

Urea flow meter is also available, too.



SuchyDataSystem GPS SENSOR

xProGPS-Nano is a reliable GPS speed sensor with CAN data output, featuring additional 3-axis MEMS accelerometer and rate gyro.

Optional OLED display available.



SOFTWARE

Dewesoft X & Leane Performance testing software

Leane developed dedicated applications based on DewesoftX for performance & consumption testing, according to customers' test protocols. The applications provide the test driver a step by step test procedure and live test results for improved efficiency on the track.

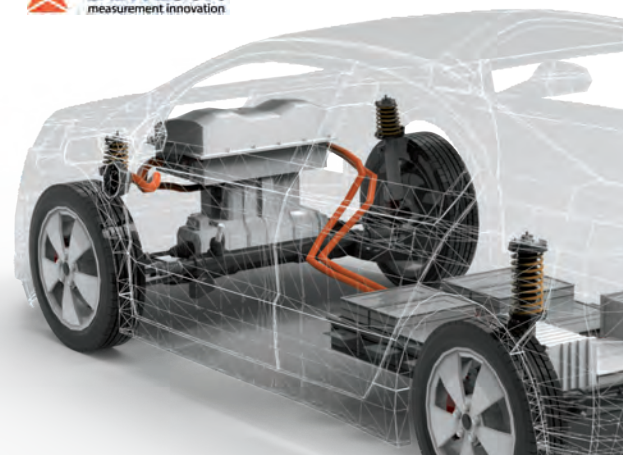



HARDWARE

SUCHY xProGPS-Max

Datalogger with embedded GPS receiver and tri-axial MEMS gyros and accelerometers, plus counter input and CAN port. A remote display with function keys allows to manage the acquisition workflow and to show live data during the measurement.

SUCHY xProOLED

High contrast display with function keys for menu navigation and remote control of the xProGPS-Max unit. Available as OLED or LCD version for improved visibility even in critical light conditions.

- Test navigation for complex test procedures
- Tachometer Calibration
- Sophisticated Brake Test package with outstanding precision
- Typical motorbike application



FUEL FLOW



SOFTWARE

LEANE PERFORMANCE ANALYSIS SYSTEM

Easy to use data analysis tool for braking, performance and fuel consumption, based on Leane python script automation libraries PyGarageLab. Import data file, display time history and GPS path on a map widget, select the type of analysis and get performance parameters.



Our added value

VEHICLE DYNAMICS, BRAKING & PERFORMANCE

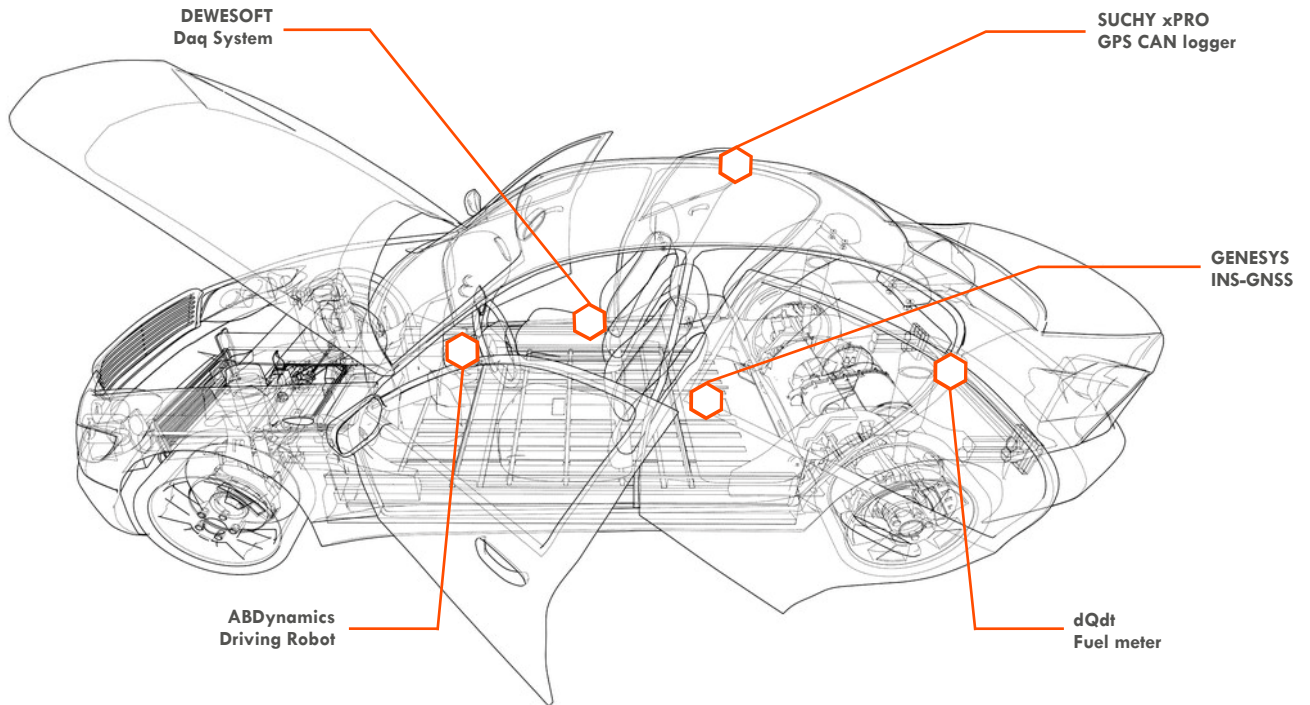

SYSTEM INTEGRATION SUPPORT:

We can help building the solution that fits your needs, providing consultancy and complementary hardware and software.



OUTSOURCING SERVICES:

We can help to carry on your test activity, on road, on track, in the lab.



MAINTENANCE AND SUPPORT SERVICES:

We can help to preserve the value of your investment and to get most performance out of it.

POWERTRAIN AND E-MOBILITY



COMBUSTION ENGINE ANALYSIS



E-MOBILITY: HYBRID AND ELECTRIC VEHICLE TESTING



FULL VEHICLE POWERTRAIN ANALYSIS WITH HUB DYNAMOMETERS



MIXED PHYSICAL AND VIRTUAL POWERTRAIN TESTING

Fields of application

A range of solutions that fit for every development stage and any type of powertrain and any driveline configuration. Our systems cover most applications on the road and in the lab.

YOUR SOLUTION	Powertrain	E.V.
	Dewesoft	■
Rototest	■	■



HARDWARE

DEWESOFT SIRIUS LINE (Combustion Analyzer)

Based on the proven and powerful Sirius dual core DAQ technology, the combustion analyzer system can either be used in-car (via the INCA interface) or it can be fully integrated into a test-bed environment. Additional synchronized acquisition from other data sources like video, GPS, CAN, FlexRay, XCP/CCP, Ethernet, can easily be combined.

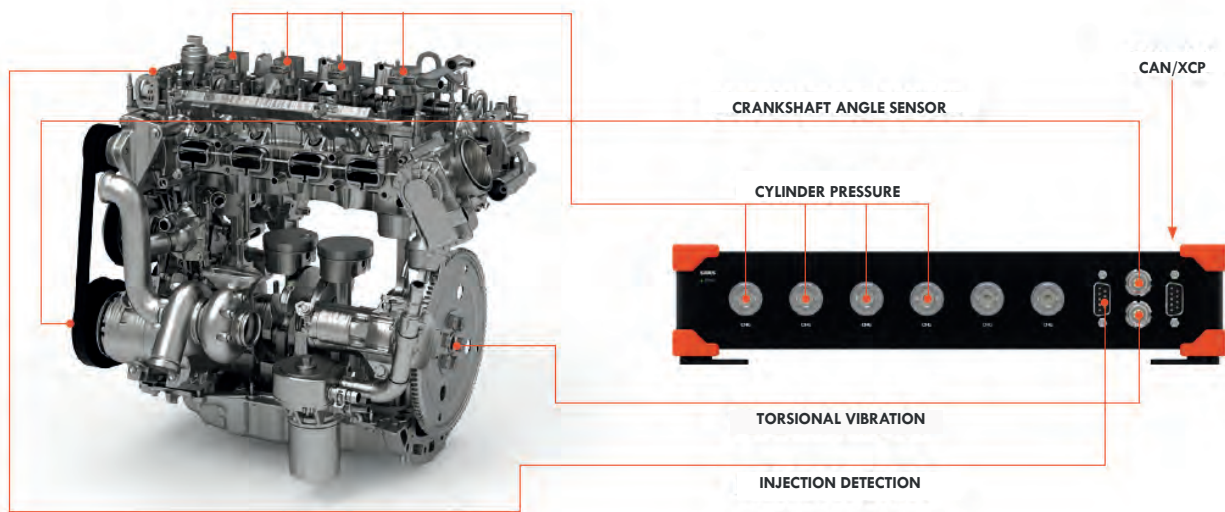

SOFTWARE

DEWESOFT X with Combustion Analysis plugin

A complete tool to perform extensive online or offline mathematical computation:

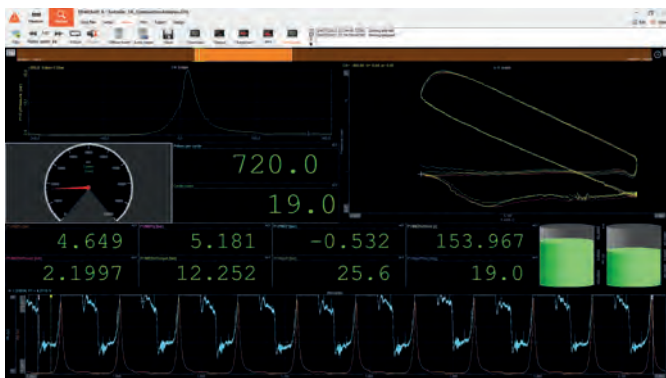

- Misfire and knock detection
- Friction analysis
- Fuel injection analysis
- Valve control system timing
- Combustion noise vibration measurement and analysis
- mechanical stress diagnosis
- Energy balance
- Gas exchange analysis
- Residual gas verification
- The exhaust gas after-treatment
- Engine mapping



HARDWARE

DEWESORT SIRIUS LINE

Compact all-in-one instrument up to 64 analog channels in one chassis. High accuracy amplifiers and extremely high speed data acquisition. The new Sirius XHS delivers up to 15 MS/s sampling rate with 5 MHz bandwidth to capture even the shortest transients. Data is transferred to any host using the open OPC UA industry-standard protocol. In parallel the data is available over XCP protocol, allowing connection to ECU calibration software packages like ETAS INCA or Vector Canape.

SIRIUS XHS-PWR

SIRIUSi XHS-PWR is a highly integrated device providing high-end data-acquisition and Hybrid ADC with a maximum sample rate of 15 MS/s at 16-bits, and 1 MS/s at 24-bits with real-time decimation filters to provide an alias-free signal at lower sample rates.

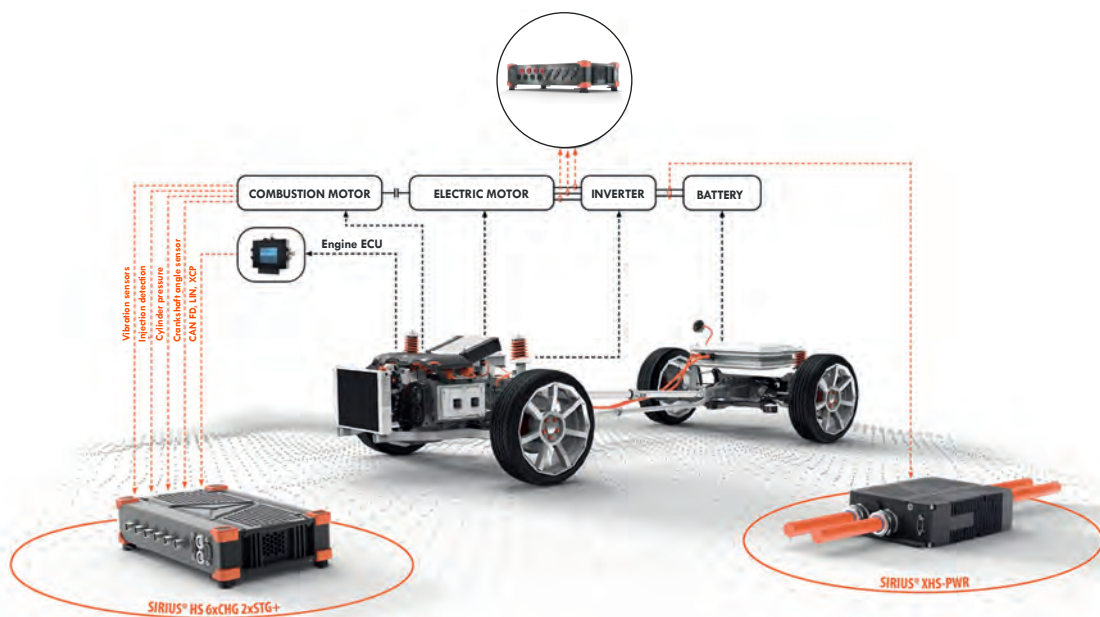

SOFTWARE

DEWESORT X with Power Analysis plugin

While the Combustion Analyzer module allows a detailed analysis of the combustion engine, the Power Analysis module allows perfect analysis of electric motor, inverter and batteries. This gives you the flexibility to test and analyze the entire vehicle with a single DAQ system.





FULL VEHICLE POWERTRAIN ANALYSIS WITH HUB DYNAMOMETERS



HARDWARE

ROTOTEST Energy wheel dynamometers

The ROTOTEST Energy powertrain dynamometer is an advanced four-quadrant dynamometer that connects to each drive wheel hub. The dynamometer features loss-free, front-end mounted, torque transducers, high resolution speed sensors and quick, versatile and fast direct-coupling to the vehicle wheel hubs. The system is ideal for many application areas including legislative driving cycles (WLTP), replication of high dynamic driving maneuvers and even ADAS testing with HIL/SIL approach.

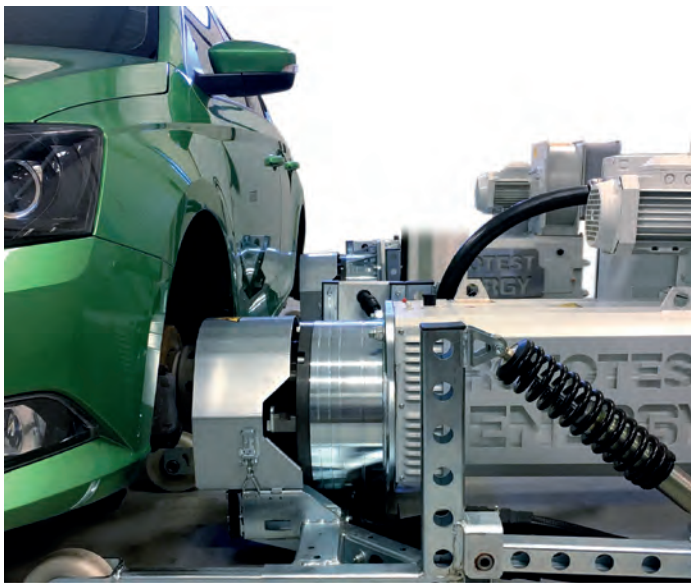

- Simple installation
- Modular system
- High dynamic response

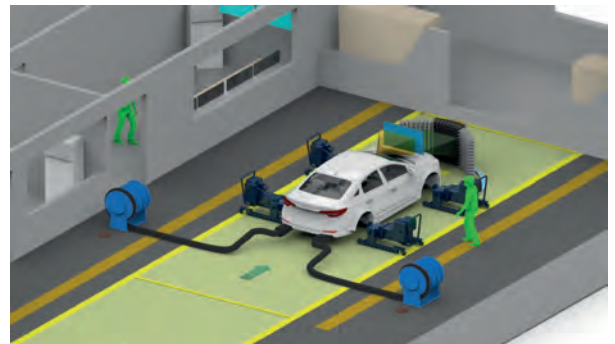

SOFTWARE

ROTOTEST control software

The ROTOTEST system is supplied as standard with software modules for road load simulation and constant speed. The system can be expanded as required with 20+ pre-defined test procedures and advanced functionalities. New modules are continuously developed over time, based on customers requirements.



- 20+ Pre-defined test, including WLTP
- Integrated vehicle model
- Simulation environment ready
- HIL/SIL interface



MIXED PHYSICAL AND VIRTUAL POWERTRAIN TESTING



HARDWARE

ROTOTEST Energy wheel dynamometers Rototest

The ROTOTEST Energy system fully supports **HiL** and **ViL** applications through its multiple interfaces with external models and real-time hardware.

Rototest High Dynamic Control technology:

- **Capability to integrate with other systems such as HiL and ViL to test complete functionality.**
- **Flexibility in configuration to support sensor fusion tests (e.g. radar, lidar, camera).**
- **Ability to conduct high dynamic tests with fast and accurate response.**
- **Functionality to support steering with force feedback without any modification of the vehicle.**



VIRTUAL VEHICLE ENVIRONMENT

- Electrical Motor
- IC Engine
- Control Units
- Clutch
- Gearbox
- Power Supply

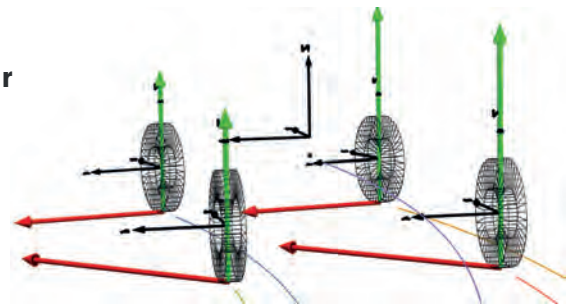

SOFTWARE

Open to third party software Rototest

Third party simulation software, e.g. IPG CarMaker®, can be interfaced with the Rototest system in order to provide realistic wheel force and speed data for the dynamometers, allowing to simulate a real powertrain fitted to a virtual vehicle on any road and any driving condition, including real driving situations involving simulated traffic and ADAS intervention.



Tailored solutions

POWERTRAIN AND E-MOBILITY

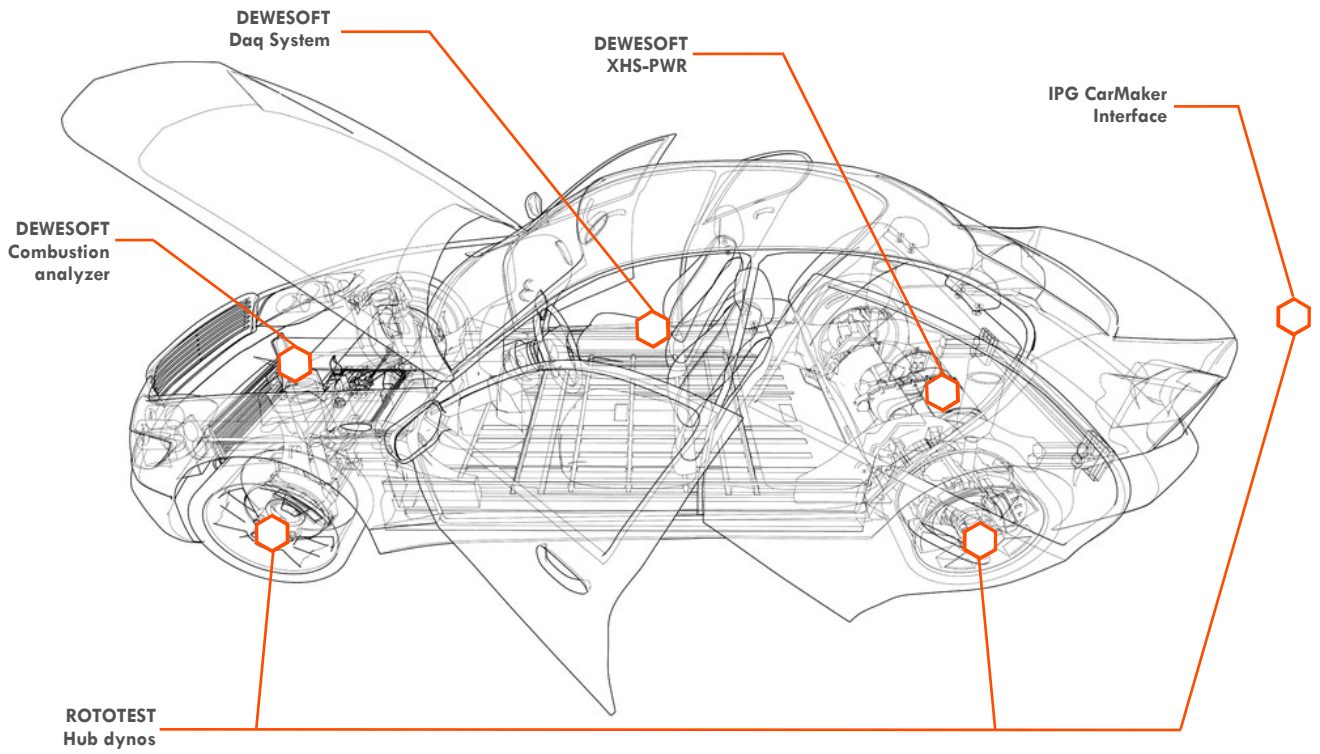

SYSTEM INTEGRATION SUPPORT:

Need to perform electrical measurements or combustion analysis on a dyno test rig? We can help you to integrate our systems into complete turnkey solutions.



CUSTOM TEST RIG CONTROL:

Need to control and acquire data from an engine test rig? We have proven expertise to design and implement test rig control Hw & Sw solutions.



MAINTENANCE AND SUPPORT SERVICES:

We can help to preserve the value of your investment and to get most performance out of it.



ADAS TESTING



ADAS DEVELOPMENT AND ASSESSMENT ON TRACK



ADAS TESTING ON PUBLIC ROAD



ADAS DEVELOPMENT WITH DRIVING SIMULATOR

Fields of application

Advanced Driver Assistance Systems (ADAS) are now fitted to many mainstream cars. Taking such systems onto the market requires complex simulation tools for virtual development and even more complex systems for track testing and homologation.

YOUR SOLUTION	ADAS
ABDynamics	■
Dewesoft	■
GeneSys	■
MoshonData	■



HARDWARE

ABD Driving Robots

Precise trajectory, vehicle-to-vehicle distance control, accurate speed profiles are key factors for effective ADAS testing. Using a CBAR (Combined Brake and Accelerator Robot), it is possible to achieve consistent speed, distance control and accurate braking inputs such as those required for Autonomous Emergency Braking (AEB) and Forward Collision Warning (FCW) tests.



ABDynamics self-driving mobile platforms

The Guided Soft Target is a pilotable target which looks like another car to your vehicle. The self-propelled platform carries a soft vehicle target (Soft Car 360), which is aerodynamically stable yet can separate into lightweight parts on impact, avoiding damage thewhole test vehicle. The LaunchPad is a small pilotable platform designed to carry Vulnerable Road User (VRU) targets for ADAS development and testing. This includes pedestrian, cyclist and moped dummies. The chassis is robust enough to cope with being driven over by a vehicle.



ADAS TARGETS

GST and LaunchPad

The ABDynamics GST and LaunchPad robot platforms are designed to cope with the latest EuroNCAP and ISO ADAS testing standard and even beyond.

The new version of the GST has improved acceleration and braking performances, thanks to the introduction of the ABS, top speed 120km/h. Increased battery capacity ensures whole day testing in typical usage conditions.

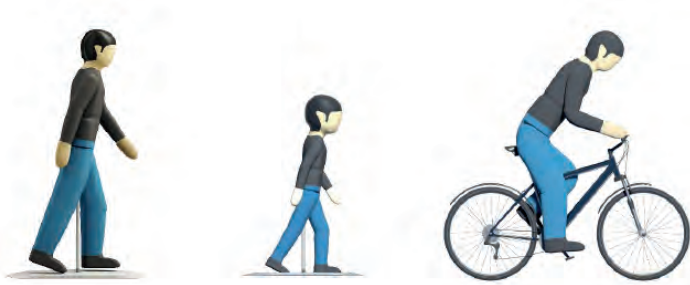

The LaunchPad 60 achieves a top speed of 60km/h and is suitable to carry on either pedestrian, cyclist and moped targets, preserving an extraordinary agility thanks to its exclusive and compact design with 4 wheel drive & steer.



- Officially approved by EuroNCAP
- Essential for EuroNCAP 2020 & next gen test protocol
- Top performance on the market
- Complex scenarios in synchro with a number of robot vehicles

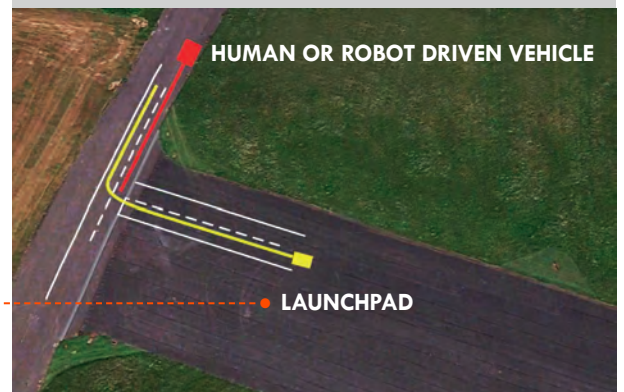

MOSHON DATA Soft Targets

A whole range of soft targets representing vehicles and VRUs for development test or homologation. A number of city scapes are available, also on request, as well as solutions for night environment testing such as the Night Environment Simulation Tunnel.



SOFTWARE

ABDynamics Robot Controller and Ground Traffic Control software suite (GTC)

The Robot Controller software is the heart of both the driving robots and the target carrier platforms. The Path Following and Synchro[®] software allow precise trajectory and synchronization of all the vehicles and targets involved in the test scenario.

The GTC station and software allow one person to manage the test execution and to keep everything under control, tracking position and speed of all the vehicles, with the ability to stop all vehicles simultaneously if necessary.

- **Enhanced scenario generation software**
- **The same user interface for driving robots and moving platforms**
- **Precise synchronization and centimeter level position accuracy**
- **Real time operation and monitoring of multiple vehicles**
- **Advanced safety functions and preventive collision check**





ADAS TESTING ON PUBLIC ROAD



HARDWARE

DEWESOFT SIRIUS LINE



All-in-one solutions based on R2DB/R1DB, or modular solutions based on S-Box and Sirius slices, interfaces for CAN, LIN, Flexray, Ethernet. Our systems allow high data-rate acquisition from multiple data sources and multiple vehicles by a dedicated WiFi network with GPS-based synchronization.

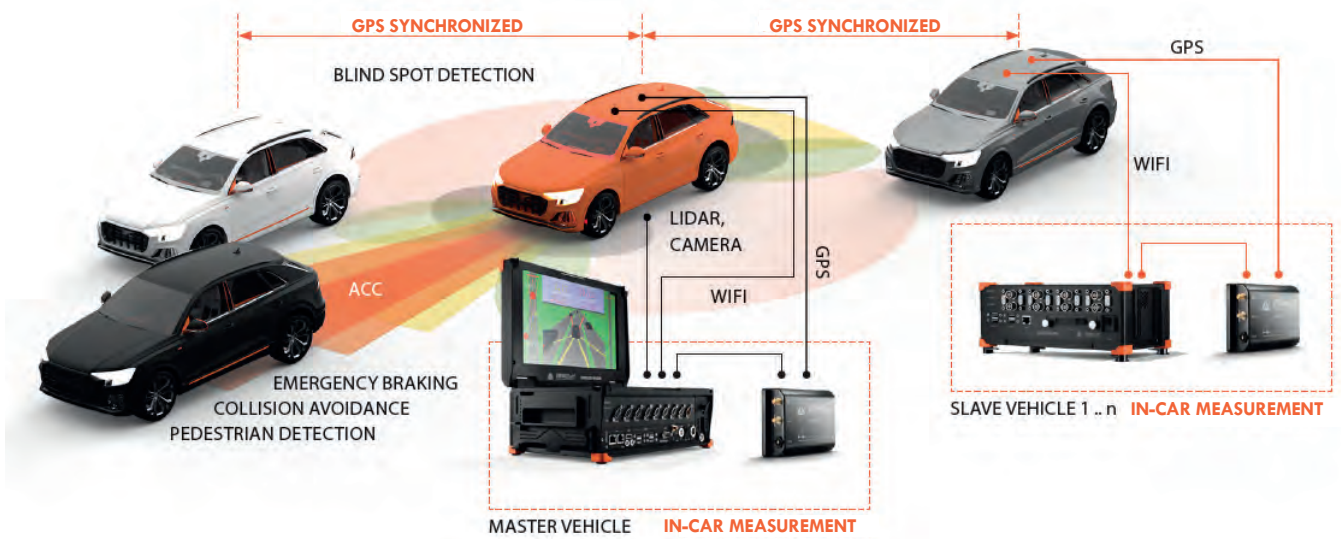

GeneSys ADMA INS-GNSS



An ADMA G-series IMU, featuring top quality accelerometers, optical gyros and GPS RTK2, is recommended for accurate measurement of the vehicle motion variables. All ADMAs have a state of the art Kalman filter that guarantees further improved stability and minimal drift. Data output via CAN and Ethernet.



- High data rate
- Any data source
- Perfectly synchronized

Advanced Driver Assistance Systems

This system enables quick and precise evaluation of driver assistance systems through synchronized data acquisition of relative movements vehicle-to-vehicle and vehicle-to-environment. The user is supported by an online visualization and an in-situ-evaluation of recorded data.

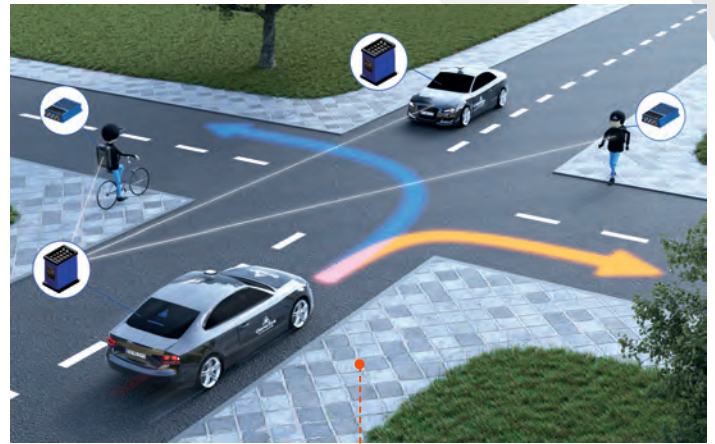

GeneSys



- Easy installation and operation
- NTRIP RTK correction shared via WiFi network
- One unit may collect live data from all vehicles

SOFTWARE

Dewesoft X with Polygon and Velodyne plugin



The Polygon plugin allows to easily perform relative distance and speed calculation between any vehicles and between vehicles and other objects or reference lines. Velodyne plugin enables acquisition and online visualization of LIDAR data in the 3Dmap visual control.

- Seamless acquisition and visualization from multiple data sources
- Visual representation of measurements in the three-dimensional virtual space





ADAS DEVELOPMENT WITH DRIVING SIMULATOR

AN ADVANCED SIMULATOR WITH CLASS LEADING DYNAMIC RESPONSE

ABDynamics' aVDS



The advanced Vehicle Driving Simulator (aVDS) is a versatile and innovative driving simulator, combining a high-performance motion platform, high specification audio and visual hardware with industry-leading virtual content from rFpro. The result is a simulator capable of accurately representing the smallest changes to a vehicle's configuration and an ideal instrument for the future of vehicle development.

- Extremely stiff structure
- Direct drive linear motors
- Ready for SIL & HIL
- High frequency response
- Immersive graphics by rFpro
- Test scenarios in simulation



A UNIQUE SOFTWARE TOOLCHAIN

ABDynamics Simpia

A whole suite of software tools allows to manage every phase in the development, bridging the gap between simulation and reality. High fidelity vehicle models can be integrated with real sensors and components in HIL environment. The same test scenarios can be translated into the real world to be executed by robotized vehicles.

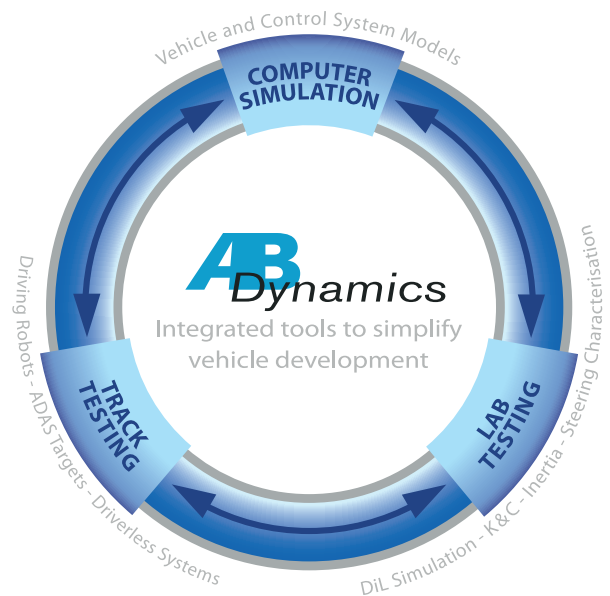

Synergy of solutions

ADAS TESTING

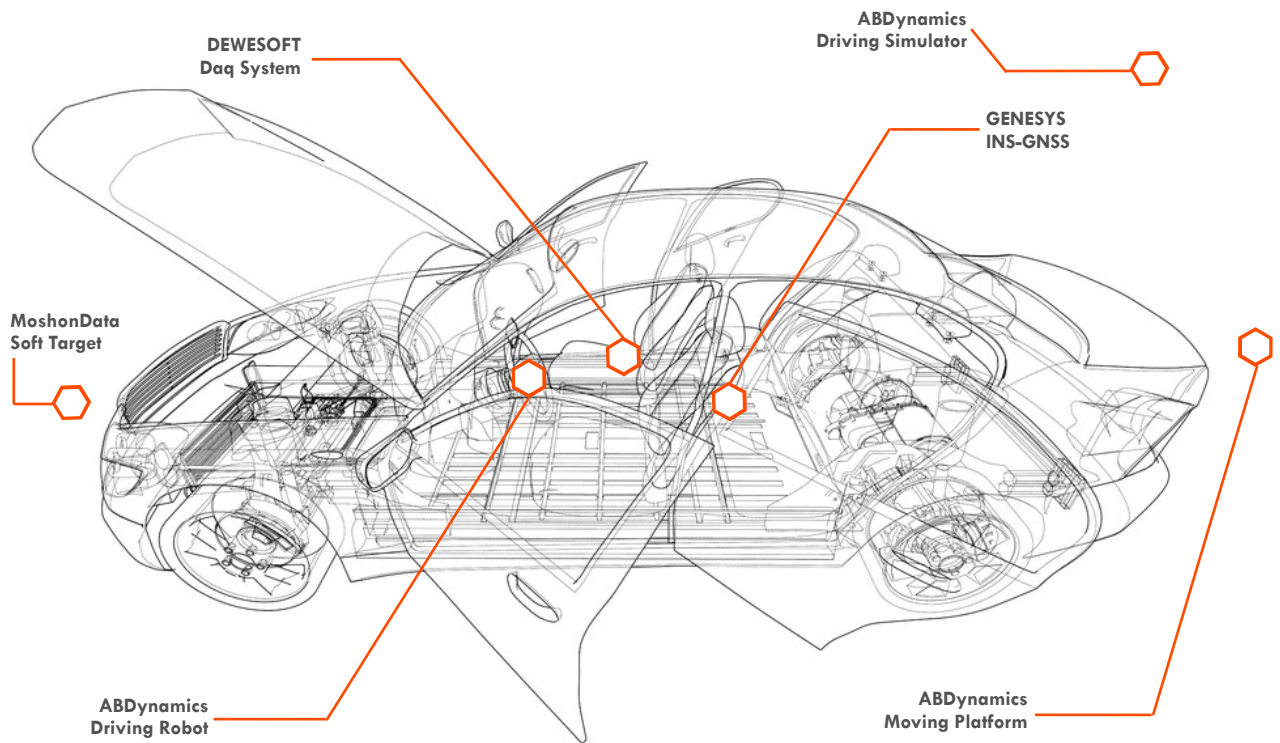

A REAL SYNERGY OF SOLUTIONS:

Through the whole product development cycle, from simulation to the road, this is what we offer.



OUTSOURCING SERVICES:

Our test engineers can support you to carry on the EuroNCAP test scenarios as well as other complex multi-vehicle scenarios that you may require during your development.



MAINTENANCE AND SUPPORT SERVICES:

We can help to preserve the value of your investment and to get most performance out of it.



DURABILITY & MONITORING



VEHICLE DURABILITY TESTING







ROAD LOAD DATA AND TEST BED INTEGRATION



LONG TERM & FLEET MONITORING

Fields of application

If you need either to setup a vehicle for a long test campaign, or to capture accurate and detailed road load data, and then to feed them into a fatigue test rig, we have a solution for you.

YOUR SOLUTION	Durability
ABDynamics	
Dewesoft	
GeneSys	
Optimeas	



HARDWARE

ABDynamics DRIVERLESS driving robots

The DRIVERLESS technology makes driving robots the ideal solution to perform precise and reproducible durability testing. Precise trajectory and accurate speed profiles are key factors in order to achieve consistent results from durability testing. Robots never get tired so they can execute the most severe test path a number of times always the same way.



ABDynamics Flex-0 by wire controller

The flex-0 by wire controller avoids to install robots by using the vehicle's built-in actuators to drive the vehicle itself. The setup includes just a motion pack with RTK option in order to guarantee the required path following accuracy and a custom communication interface between the Flex-0 controller and the vehicle network (the development of the communication interface is in charge to the customer).



- Reproducible inputs
- Driverless technology
- Durability & misuse





ROAD LOAD DAT AND TEST BED INTEGRATION

A UNIQUE HARDWARE & SOFTWARE SOLUTION

DEWESOFT R8 LINE DEWESoft[®] measurement innovation

The R8 instruments can be configured with up to 128 analog channels, 64 counter channels, 192 digital channels, 8 CAN ports, 100 Hz GPS sensor interface for CAN, CAN FD, XCP/CCP in a compact and robust chassis. Display and high capacity battery are available as option. Up to 64 analog outputs can be added in order to drive external actuators. Can be powered directly from the vehicle battery and/or can be optionally configured with an internal high capacity Li-ion battery for maximum reliability.

The worlds of data acquisition and control co-exist in the R8rt: it includes a real time EtherCAT slave interface which can be used to provide real-time data to a 3rd party control system while the internal bus allows full-speed data recording to Dewesoft X software in parallel.

So, the integration with a test bed, e.g. MTS road simulator becomes easier and cost effective.

- No need for hundreds meters of cables
- No need for a high level analog input stage on the controller side



- With 8 SIRIUS slices
- Powerful SBOX computer
- Real time EtherCAT[®] slave interface



Front Panel



Back Panel

- Up to 128 analog inputs
- Up to 64 analog outputs
- Dual mode
- Software included





LONG TERM & FLEET MONITORING



UNIVERSAL IOT DEVICE

OPTIMEAS smartMINI & smartRAIL

The smartMINI compact data logger is the standard device for loss-free recording and transmission of machine and system data. SmartMINI stands out for its high performance capabilities and robust design. SmartRAIL offers a specialised device for condition monitoring and condition-based maintenance in railway transportation.



- Simple & smart
- Continuous, loss-free data recording
- Fast data transmission
- Integrated monitoring function
- Easy to handle, easy to integrate

OPTIMEAS optiCLOUD

The optiCLOUD is the central storage, communication and control unit for a wide range of IoT applications. The large amount of data collected by the Edge devices are stored, processed and made available to authorised users on the web, anytime and anywhere.



- Seamless, loss free data recording
- Non-reactive connection
- Passive cooling concept to 85°Celsius



Our added value

DURABILITY & MONITORING

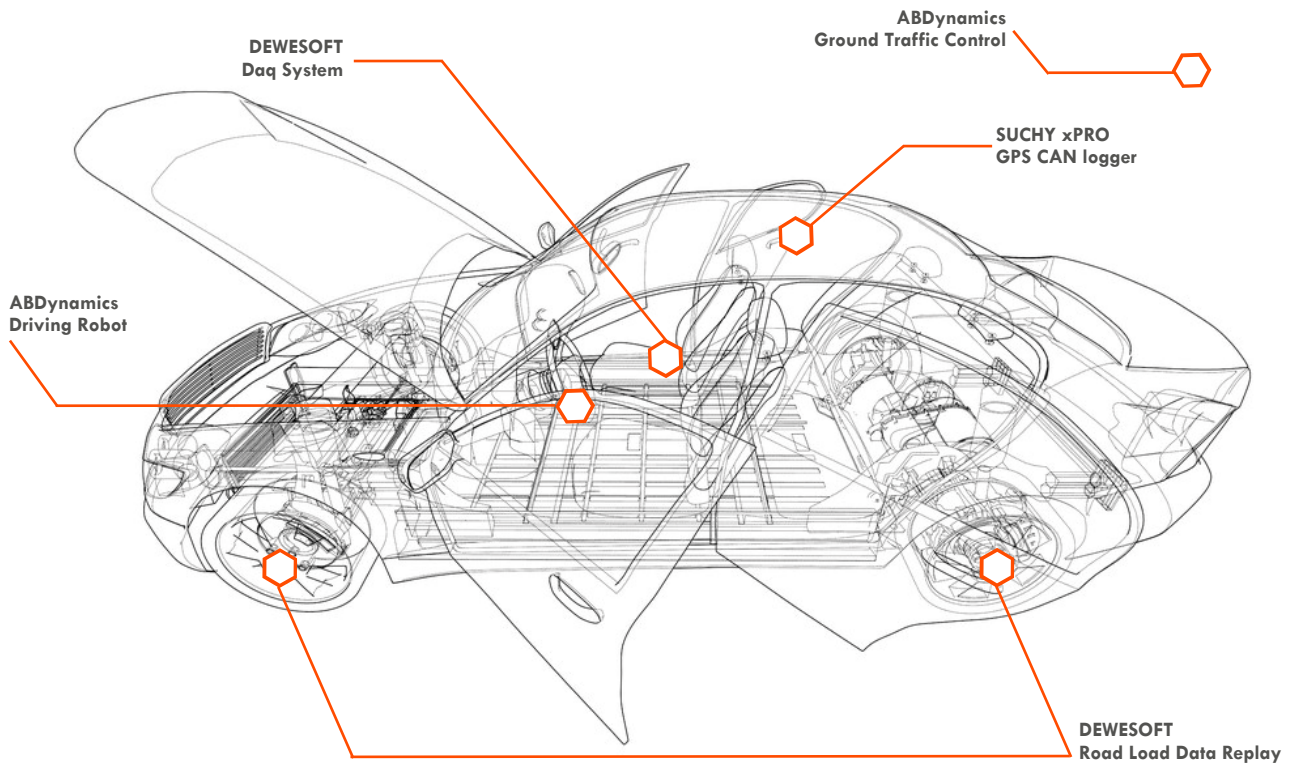

SYSTEM INTEGRATION SUPPORT:

We can help building the solution that fits your needs, providing consultancy and complementary hardware and software.

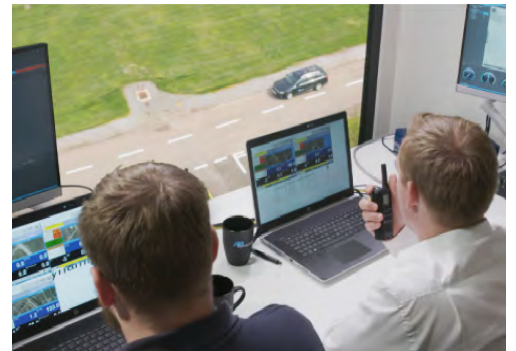

OUTSOURCING SERVICES:

We can help to carry on your test activity, on road, on track, in the lab.



MAINTENANCE AND SUPPORT SERVICES:

We can help to preserve the value of your investment and to get most performance out of it.

Your Professional Team Support



State of the art testing equipment

Thanks to many years of experience in the field of sensors and data acquisition systems, a long time collaboration with car makers and OEMs, our team include professional drivers, skilled test engineers and experts in test data analysis; Leane can support your activities with tailored solutions for data acquisition, analysis, validation and reporting.

Leane International is official distributor, entitled to provide training, technical support and maintenance service of:



A wide range of transducers for complete vehicle measurement: linear and angular displacement, force & torque, pressure, temperature, etc.



A partner for complete vehicle development, from DIL simulation to K&C measurements to vehicle dynamics, ADAS and durability track test, driverless robot vehicle control.



Cutting edge data acquisition technology. Award winning daq software and high performance hardware for a wide range of test applications.



Top quality range of fuel flow meters, from high dynamic fuel rate to extremely low flow of adBlue and down to the measurement of component leakage.



State of the art GNSS/Inertial solutions for high accuracy vehicle dynamics/ADAS/ACC/AEBS and position measurement.



All kind of complements and accessories for real world ADAS testing: moving soft targets, city scapes (SIM CITY), night environment simulation and lighting solutions.



Smart solutions for automotive measurements, monitoring and service in the age of IoT and Industry 4.0



Electric wheel hub active dynamometers to test all the types of powertrain (ICE, HEV, BEV) according to regulations in a wide variety of conditions, also coupled with real-time vehicle simulation models (HIL).

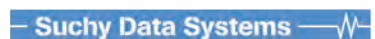

Compact solutions for vehicle performance and durability testing: logger, GNSS, IMU, temperature.

HEADQUARTER
LEANE INTERNATIONAL SRL
Automotive Division

Viale Partigiani d'Italia, 1 43123 Parma
Phone: +39 0521.242495
info@leane.it
www.leaneautomotive.com
www.leane.it

